

# ALFA

BRAD / FAG / STEJAR

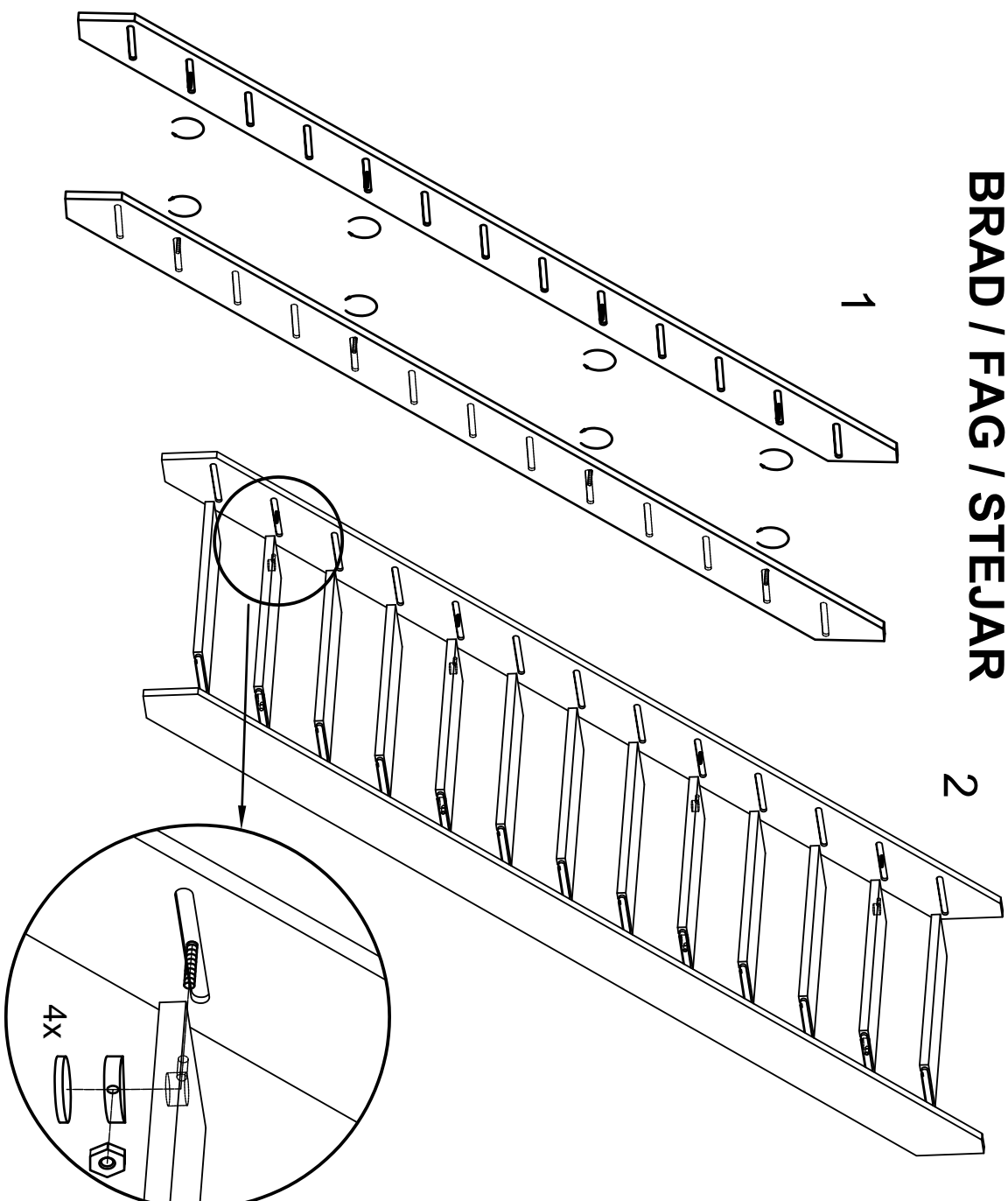

8X  
M8x70



8X

8X  
M8



8X

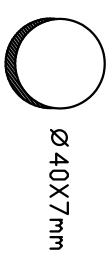

Ø40X7mm

1X

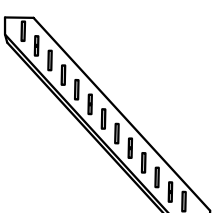

1X

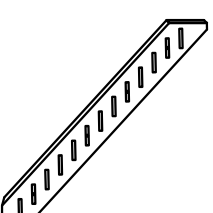

2 Laterala pentru scara dreapta

8.08.2011

# ALFA

BRAD / FAG / STEJAR

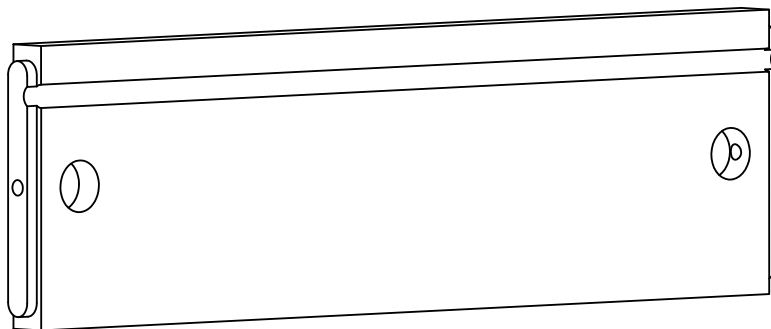

= 4

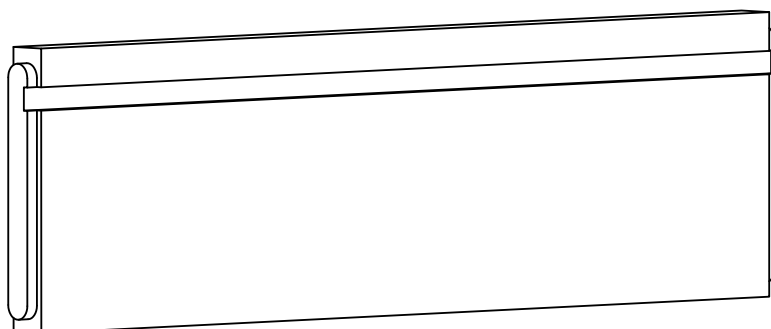

= 9

1 / 1

13 trepte pentru scara dreapta sau cu turnanta

8.08.2011

# ALFA

BRAD / FAG / STEJAR

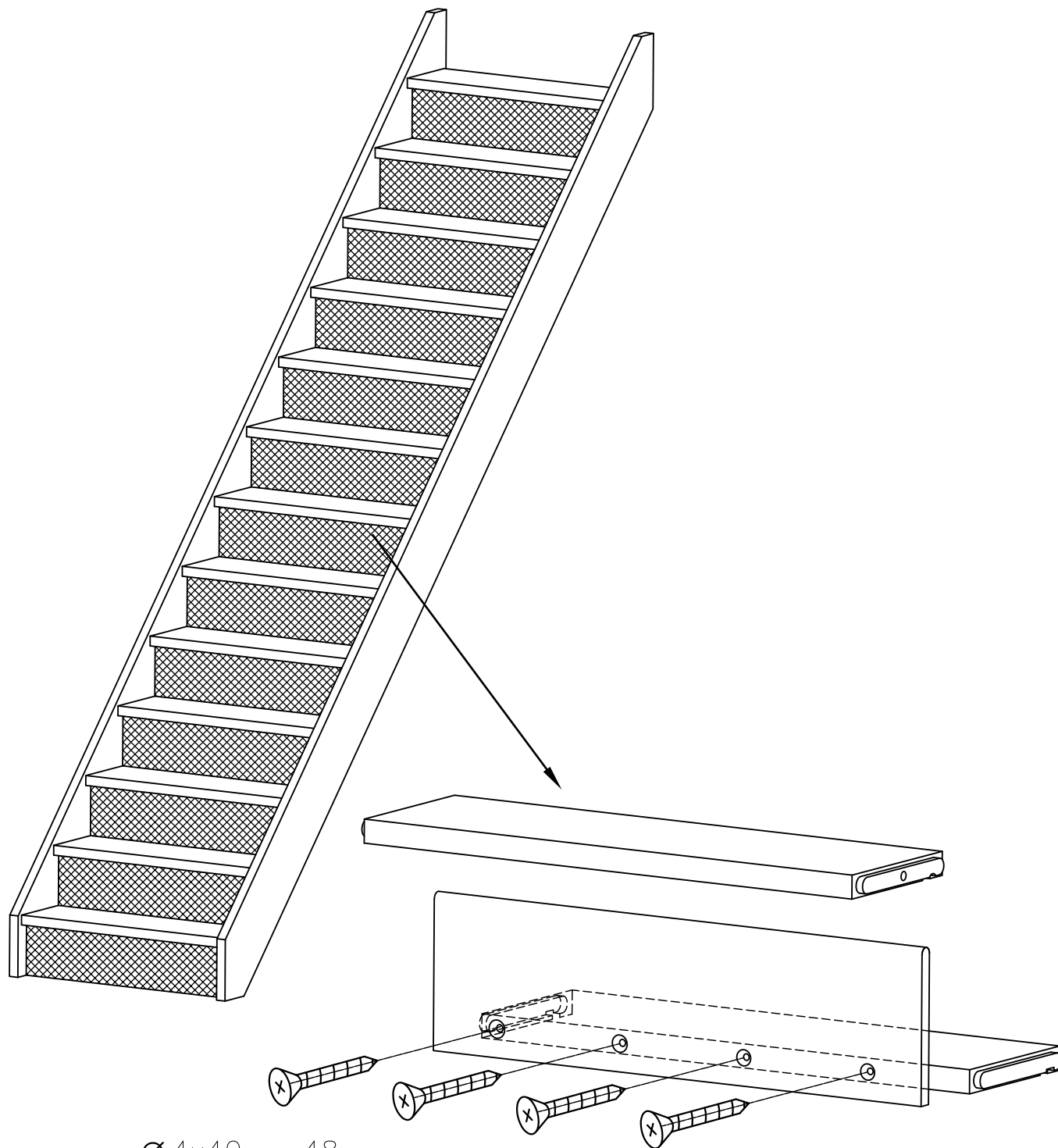

Ø 4x40 = 48

1 / 1

13 contratrepte pentru scara dreapta sau cu turnanta 8.08.2011