

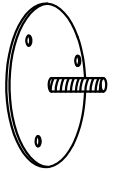









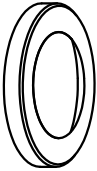
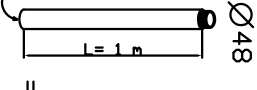
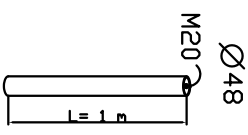



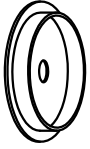

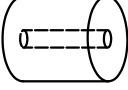
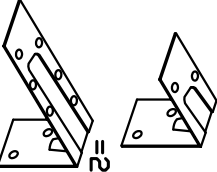



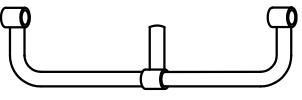







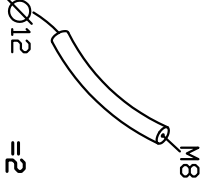
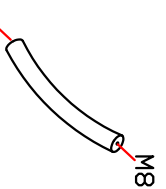
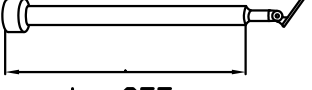

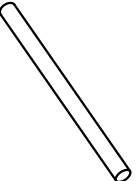







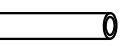
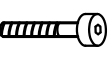
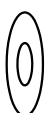

A1		=1
A2	 12 mm Ø12	=3
A3	 Ø8x80	=3
A4		=1
A5	 Ø48 M12	=1
A6	 Ø48 M20	=1
A7	 M12	=1
A8		=1
A9	 20 mm A20	=1
A10	 M20	=2
A11		=26
A12		=8
A13		=52
A14		=13
A15	 =2	=2
A16	 5x25	=12
A17	 6x80	=8
A18		=2
B1		=1
B2	 3,5x13mm	=7
B3	 1120 mm	=13
B4	 937 mm	=12
B5	 1012 mm	=12
B6	 4X16	=90
B7	 M8x40mm	=11
B8		=11
B9	 Ø12 M8	=2
B10	 M8 =10	=10
B11	 955	=1
B12	 955 mm	D120 =6
B13	 D145	=7
B14		=4
B15		=1
B16		=2
B17	 5x50	=2
B18	 10 mm Ø10	=10

<p>C1</p>  <p>12 mm</p> <p>Ø12</p> <p>=2</p>	<p>C2</p>  <p>M8x80</p> <p>=2</p>	<p>C3</p>  <p>=33</p>	<p>C4</p>  <p>=35</p>	<p>C5</p>  <p>174 mm</p> <p>=1</p>	<p>C6</p>  <p>M8x70mm</p> <p>HEX 5=1</p> <p>=31</p>	<p>C7</p>  <p>8 mm</p> <p>A8</p> <p>=31</p>	<p>C8</p>  <p>=50</p>	<p>C9</p>  <p>=25</p>
<p>C10</p>  <p>=25</p>	<p>C11</p>  <p>M6x6</p> <p>HEX 3=1</p> <p>=26</p>	<p>C12</p>  <p>=2</p>	<p>C13</p>  <p>M8x90mm</p> <p>=1</p>	<p>C14</p>  <p>=1</p>	<p>C15</p>  <p>=12</p>			
<p>D1</p>  <p>=12</p>	<p>D2</p>  <p>=1</p>							

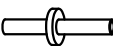

D 1200 mm

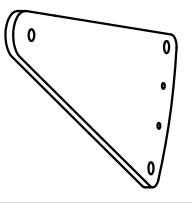
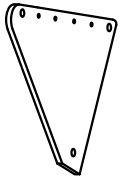
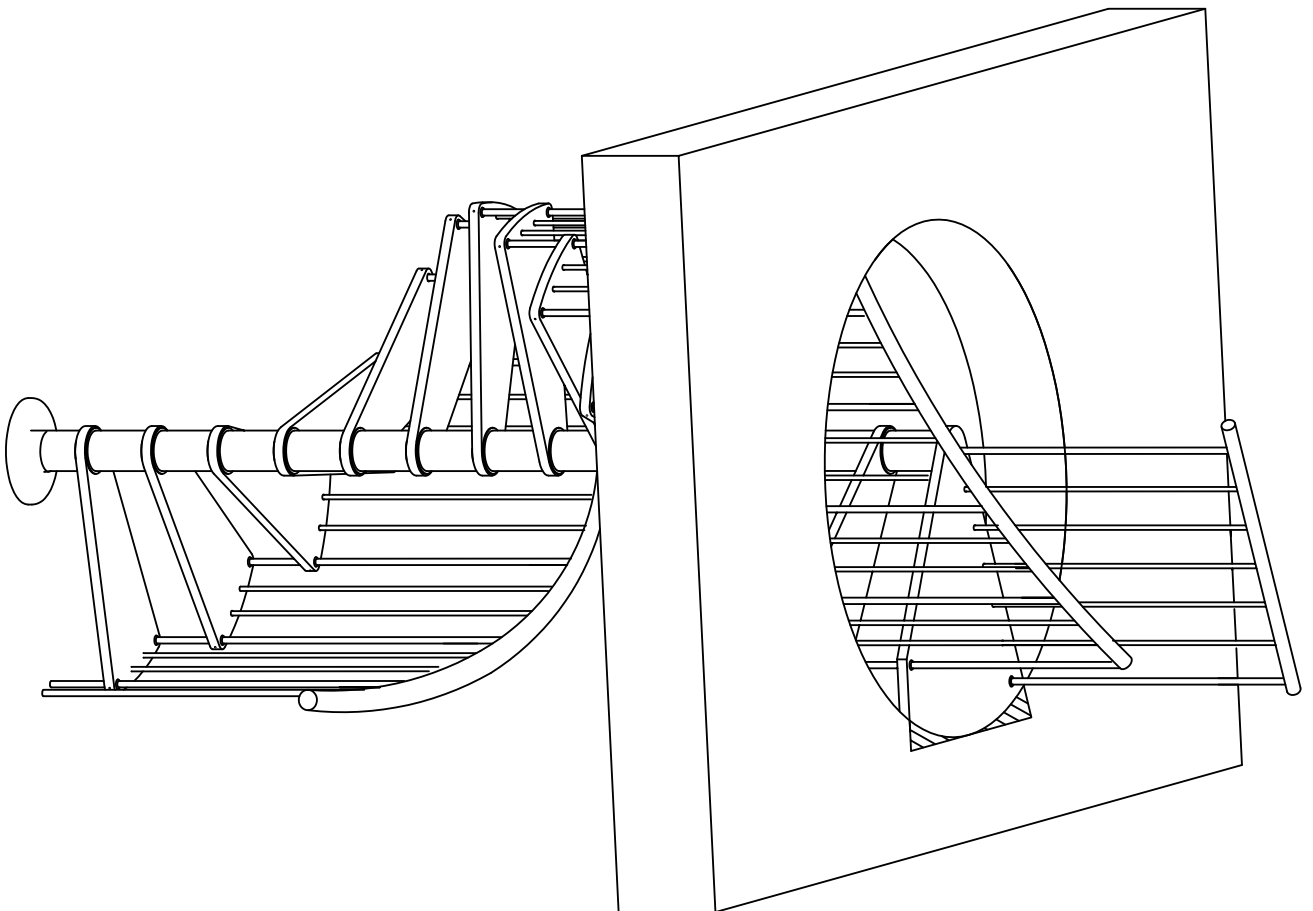
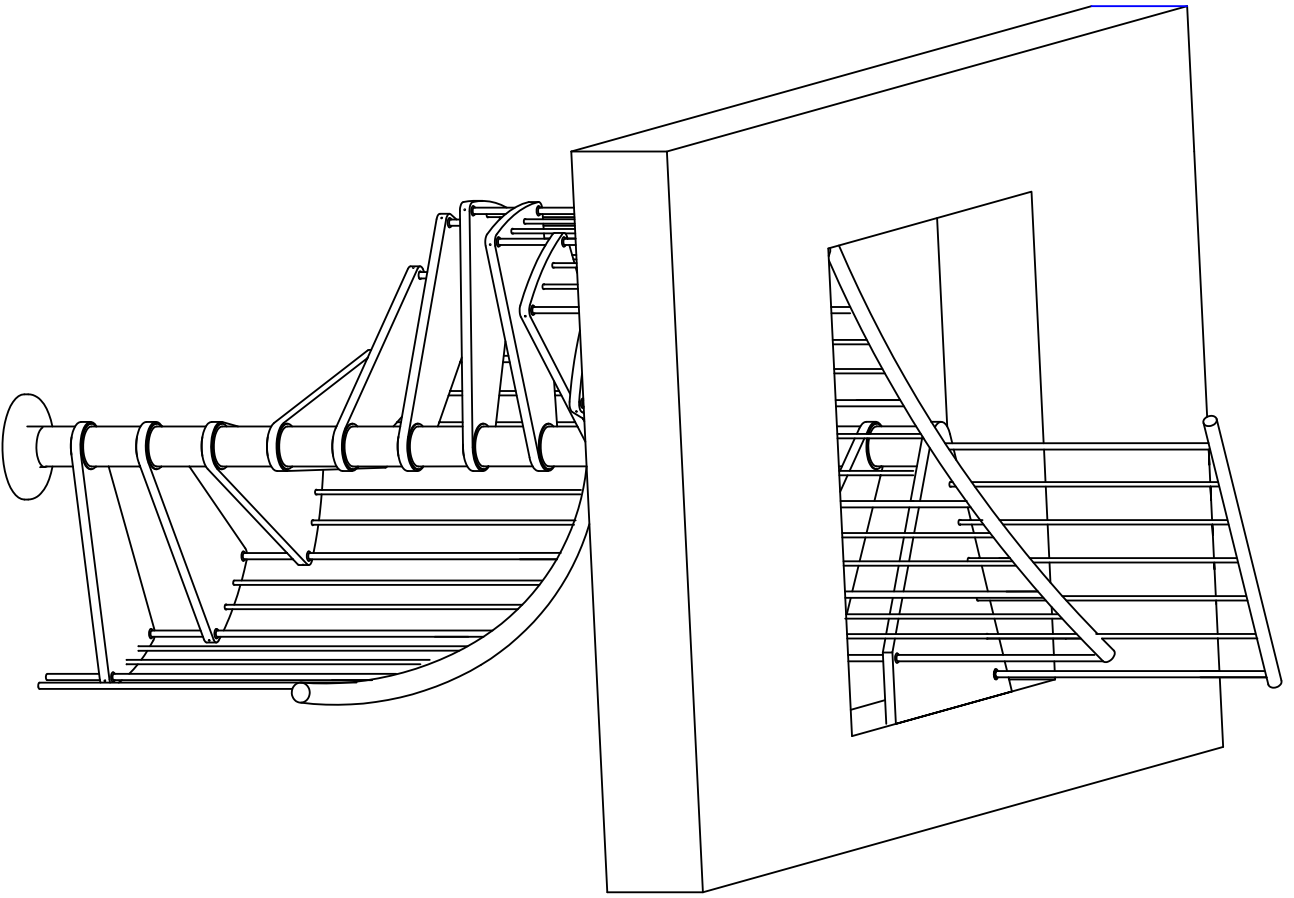
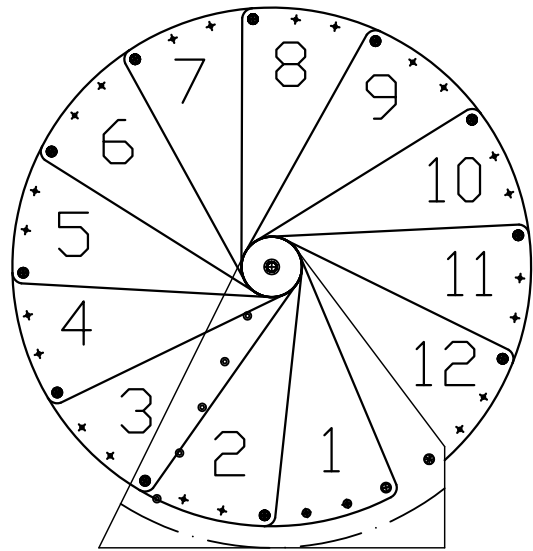
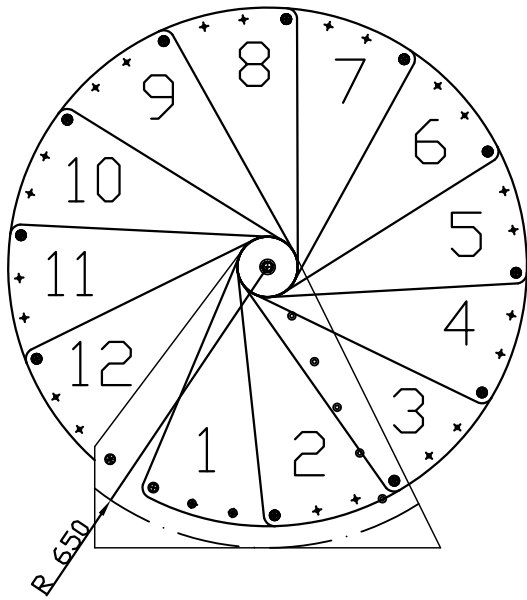

D 1450 mm

