

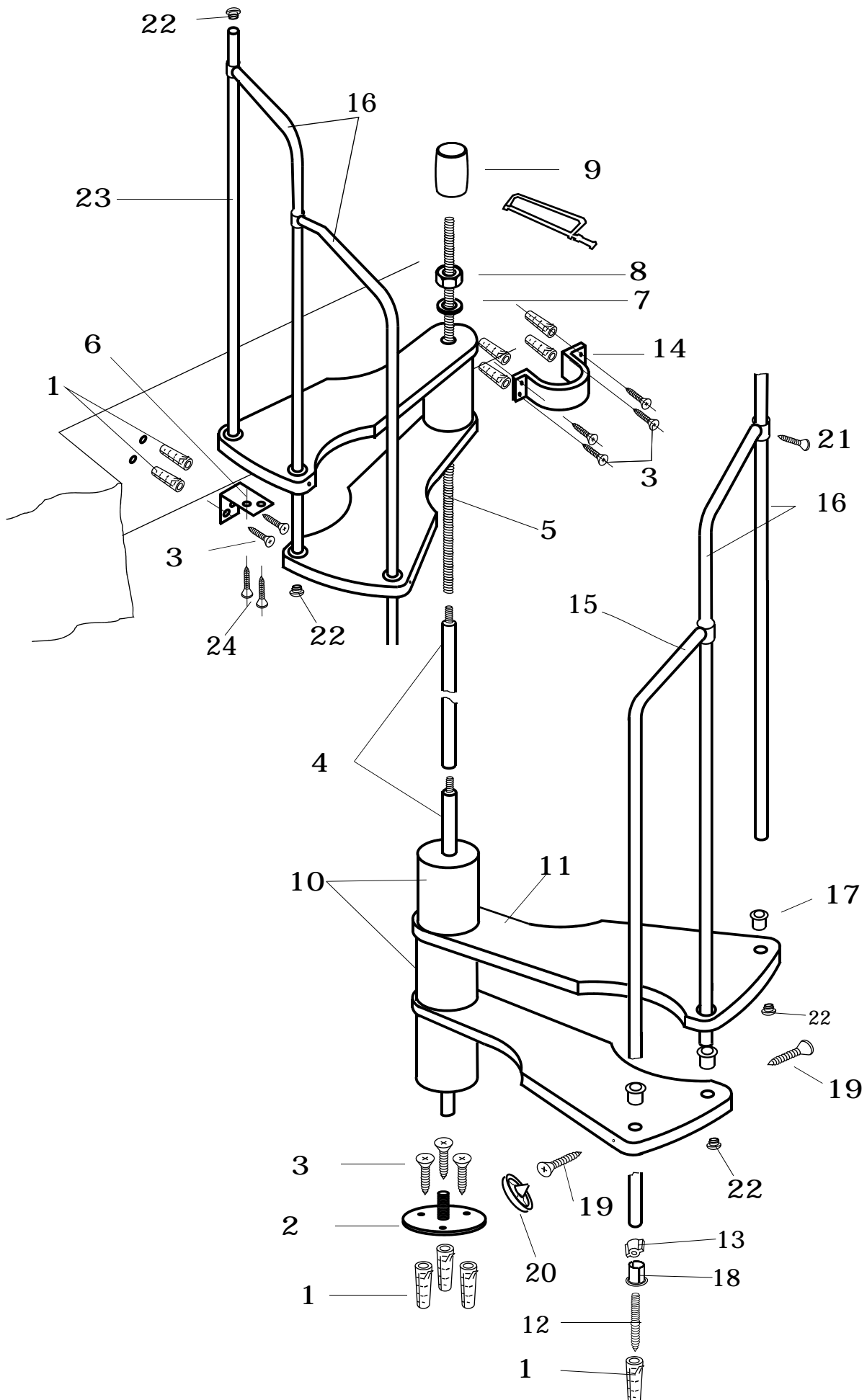









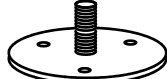
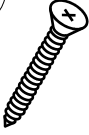

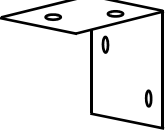

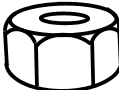

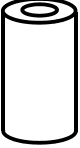
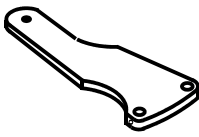
SINOPE 120 / 140

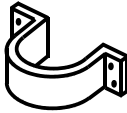
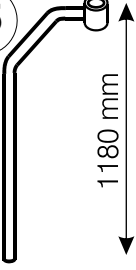
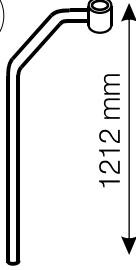
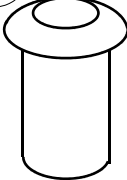
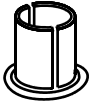

SINOPE 120 / 140

| | | | | | |
|--|--|---|---|---|---|
| <p>1</p>  <p>Ø10</p> <p>=10</p> | <p>2</p>  <p>=1</p> | <p>3</p>  <p>6X80 mm</p> <p>=9</p> | <p>4</p>  <p>=2</p> | <p>5</p>  <p>=1</p> | <p>6</p>  <p>=1</p> |
| <p>7</p>  <p>=1</p> | <p>8</p>  <p>=1</p> | <p>9</p>  <p>=1</p> | <p>10</p>  <p>=12</p> | <p>11</p>  <p>=12</p> | <p>12</p>  <p>M8X80mm</p> <p>=1</p> |
| <p>13</p>  <p>=1</p> | <p>14</p>  <p>=1</p> | <p>15</p>  <p>1180 mm</p> <p>=1</p> | <p>16</p>  <p>1212 mm</p> <p>=11</p> | <p>17</p>  <p>=24</p> | <p>18</p>  <p>=1</p> |
| <p>19</p>  <p>6X60mm</p> <p>=24</p> | <p>20</p>  <p>=24</p> | <p>21</p>  <p>4,2X13 mm</p> <p>=12</p> | <p>22</p>  <p>=13</p> | <p>23</p>  <p>=1</p> | <p>24</p>  <p>4x25mm</p> <p>=2</p> |

