

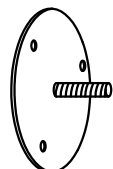









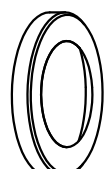
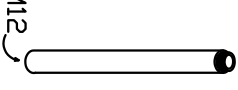
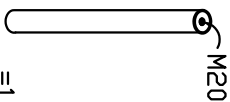
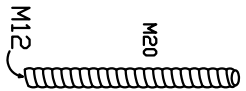



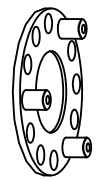
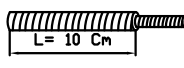
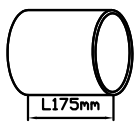
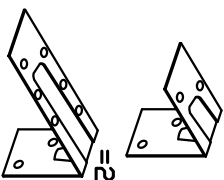



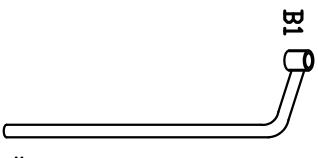
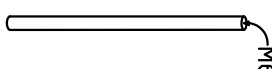



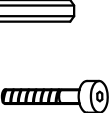
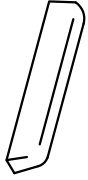
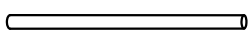
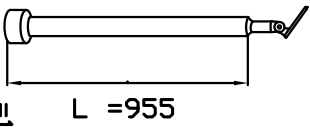
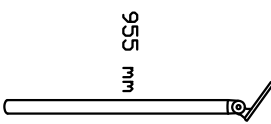





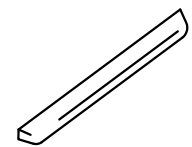

A1		=1
A2	 12 mm Ø12	=4
A3	 Ø8x80	=3
A4		=1
A5	 M12	=1
A6	 M20	=1
A7	 M20 M12	=1
A8		=1
A9	 20 mm A20	=1
A10	 M20	=2
A11		=78
A12	 5 10 C 1	=1
A13	 L175mm	=13
A14		=2
A15	 5x25	=12
A16	 6x80	=8
A17		=8
A18		=2
B1		=1
B2	 M6	=12
B3		=11
B4	 4x25	=24
B5	 4x13mm	=14
B6	 M6x20mm HEX 5=1	=12
B7		=12
B8		=1
B9	 955	=1
B10	 955 mm	D120 D140 D160 =5 =6 =7
B11	 4X16	=88
B12		=1
B13		=1
B14	 5x50	=2
B15	 Ø10	=10
B16		=37
B17	 M6x6mm HEX3=1	=37

B18 4X30mm 	B19 	B20 	B21 4x13mm 					
C1  M8x80 =1	C2 	C3 	C4  M8x60mm D120 D140 D160 =5 =6 =7	C5 8 mm  A8 =7	C6 	D1 	D2 	

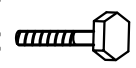

FLAMENCO D 120/140/160

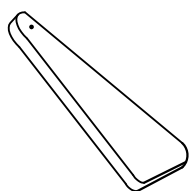
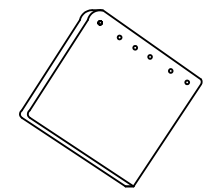
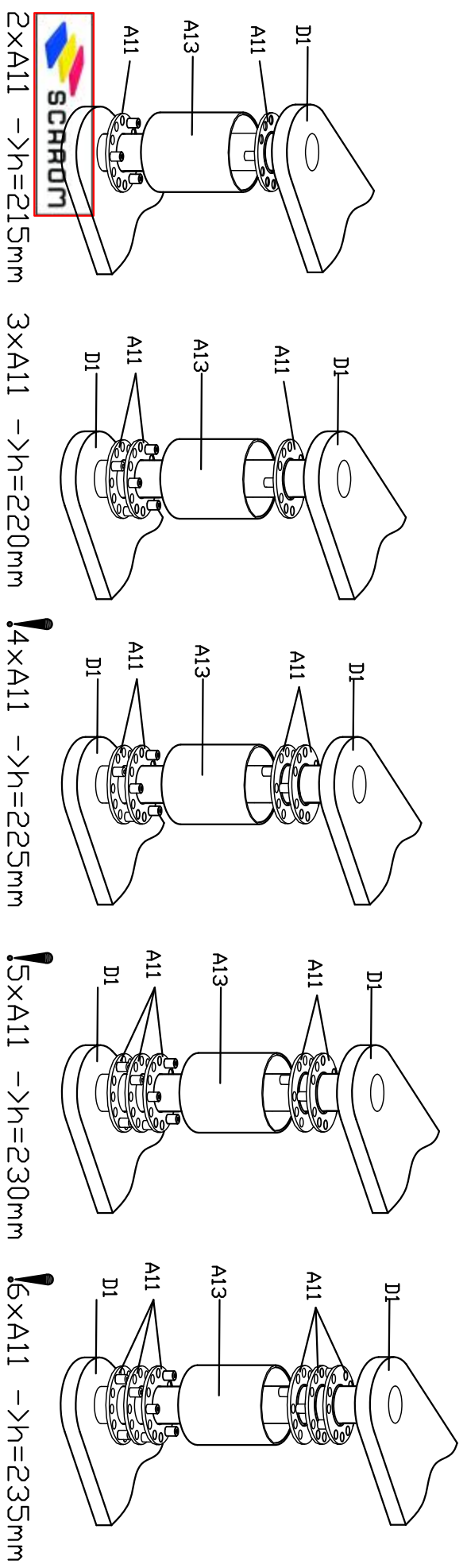
CLASSIC

15.06.2012

5/5