

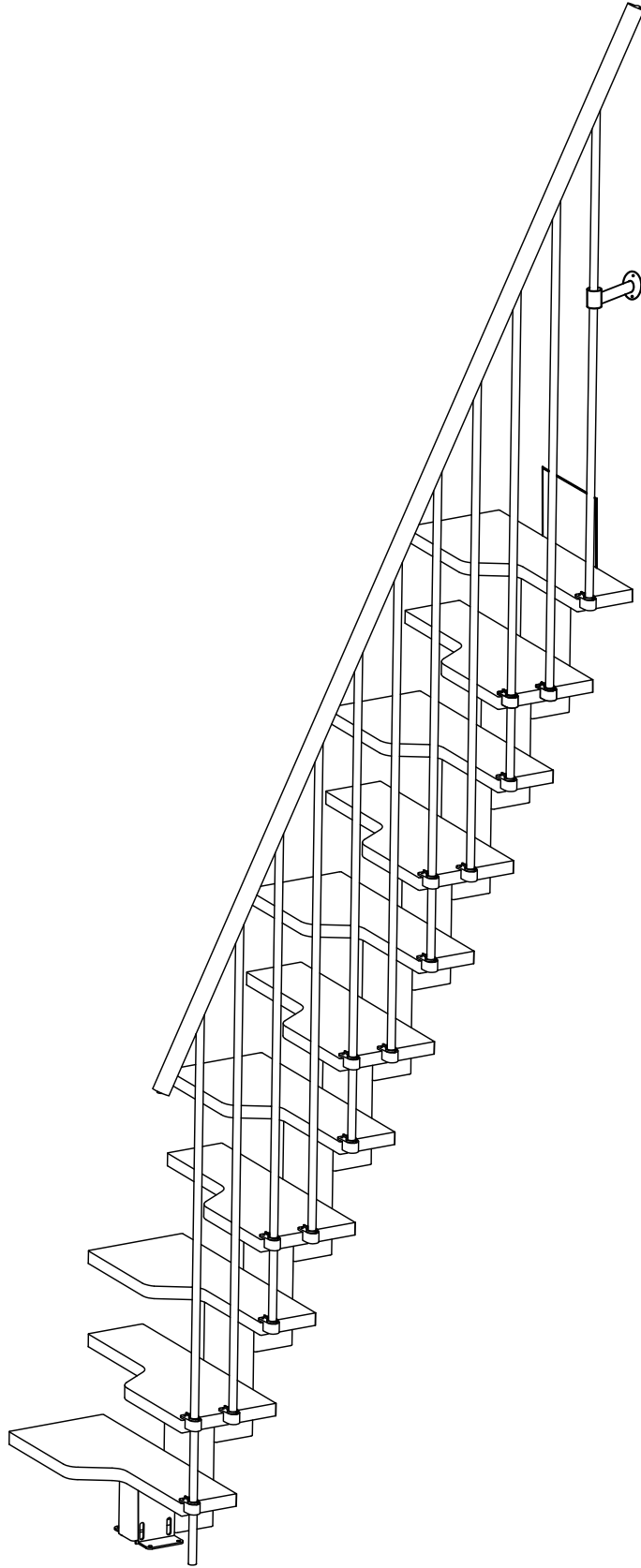

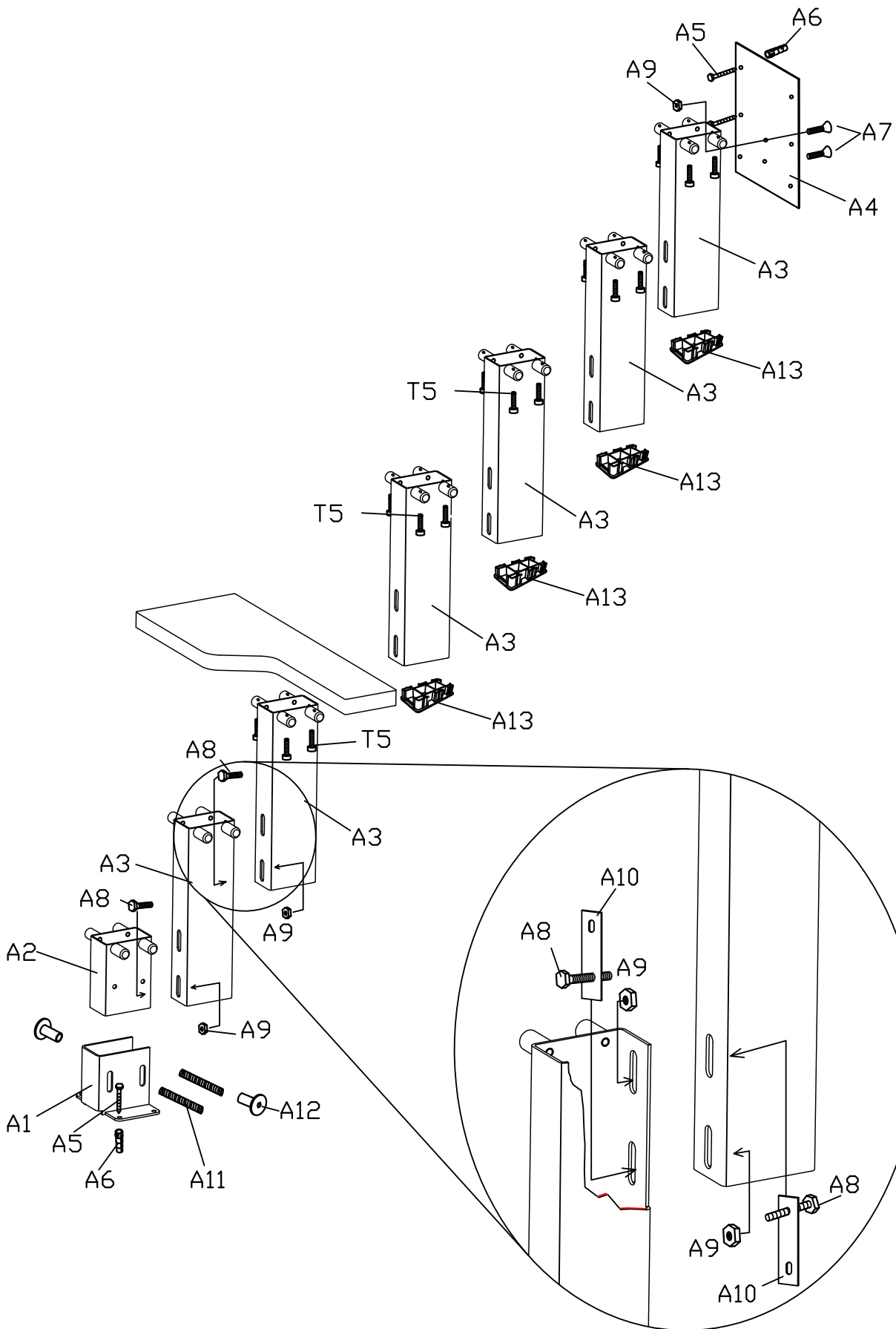

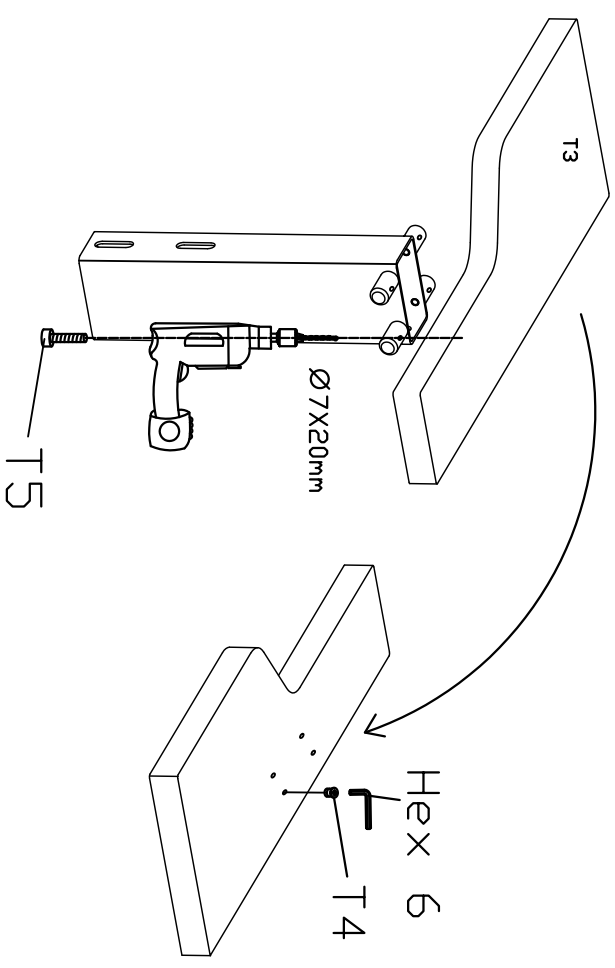

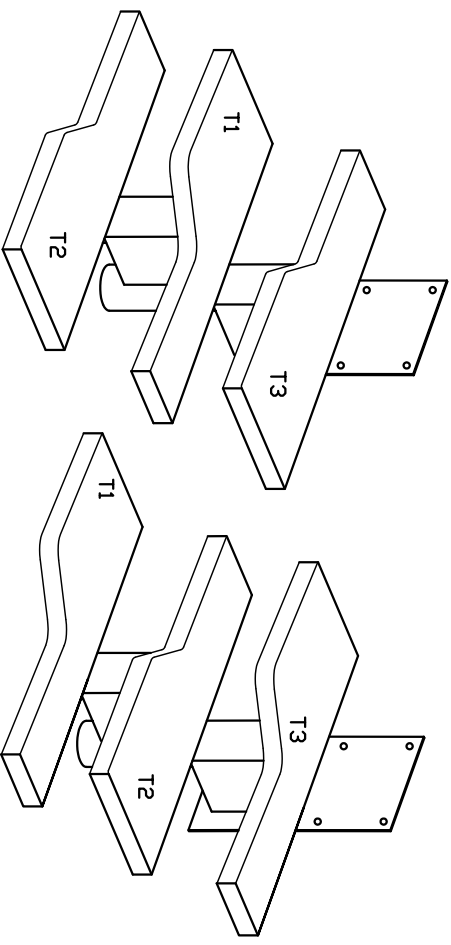

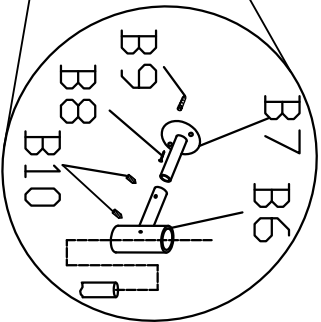
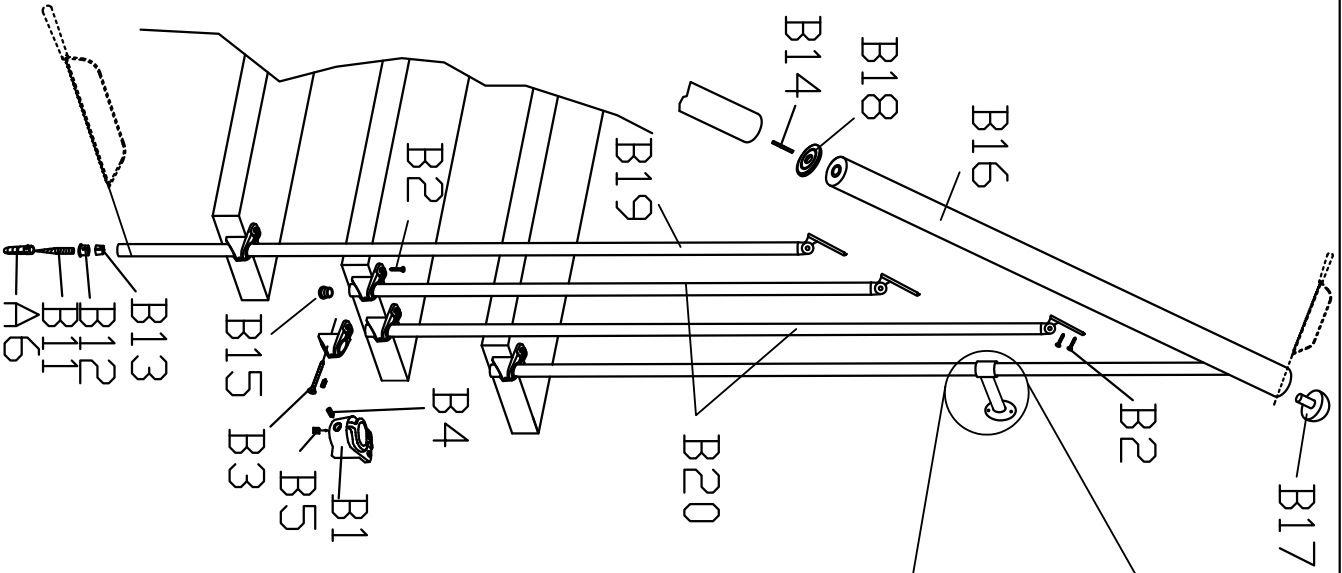

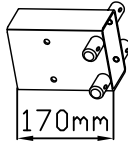
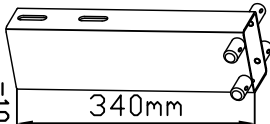
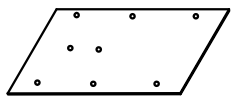





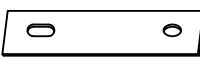

















# ANDRE

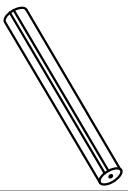



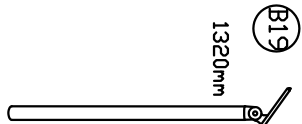

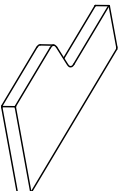
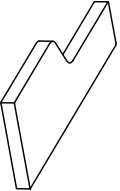
<p>(A1)</p>  <p>=1</p>	<p>(A2)</p>  <p>=1</p>	<p>(A3)</p>  <p>=10</p>	<p>(A4)</p>  <p>=1</p>	<p>(A5)</p>  <p>8x80</p> <p>=8</p>	<p>(A6)</p>  <p>Ø 12</p> <p>=9</p>	<p>(A7)</p>  <p>M10x20</p> <p>=2</p>	<p>(A8)</p>  <p>M10x16</p> <p>=20</p>	<p>(A9)</p>  <p>M10</p> <p>=22</p>
<p>(A10)</p>  <p>=20</p>	<p>(A11)</p>  <p>M8x55</p> <p>=2</p>	<p>(A12)</p>  <p>M8</p> <p>=4</p>	<p>(A13)</p>  <p>=10</p>					
<p>(B1)</p>  <p>=16</p>	<p>(B2)</p>  <p>4x16mm</p> <p>=54</p>	<p>(B3)</p>  <p>4X30mm</p> <p>=16</p>	<p>(B4)</p>   <p>M6x6mm</p> <p>=16</p>	<p>(B5)</p>  <p>=16</p>	<p>(B6)</p>  <p>=1</p>	<p>(B7)</p>  <p>=1</p>	<p>(B8)</p>  <p>5x50mm</p> <p>=2</p>	<p>(B9)</p>  <p>Ø 10</p> <p>=2</p>
<p>(B10)</p>  <p>4,2x13mm</p> <p>=2</p>	<p>(B11)</p>  <p>M8x80mm</p> <p>=1</p>	<p>(B12)</p>  <p>=1</p>	<p>(B13)</p>  <p>=1</p>	<p>(B14)</p>  <p>M8x40mm</p> <p>=2</p>	<p>(B15)</p>  <p>=10</p>	<p>(B16)</p>  <p>=3</p>	<p>(B17)</p>  <p>=2</p>	<p>(B18)</p>  <p>=2</p>

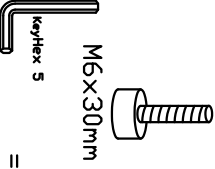
 <p>B19 1320mm</p> <p>=1</p>	 <p>B20 1130mm</p> <p>=10</p>							
 <p>T1</p> <p>=5</p>	 <p>T2</p> <p>=5</p>	 <p>T3</p> <p>=1</p>	 <p>T4</p> <p>=4</p>	 <p>T5</p> <p>M6x30mm keyHex 5</p> <p>=44</p>				

ANDRE